

1ST PRINTING OCTOBER '02



Universal Kit

Kit Installation Instructions
& Service Manual

Switchable **FROM** High Resolution 31K
TO Standard (Low) Resolution 15.75K.

1 - 2 PLAYER GAME

SEGA ENTERPRISES, INC. USA

MANUAL NO. 999-1517

VISIT OUR WEBSITE!

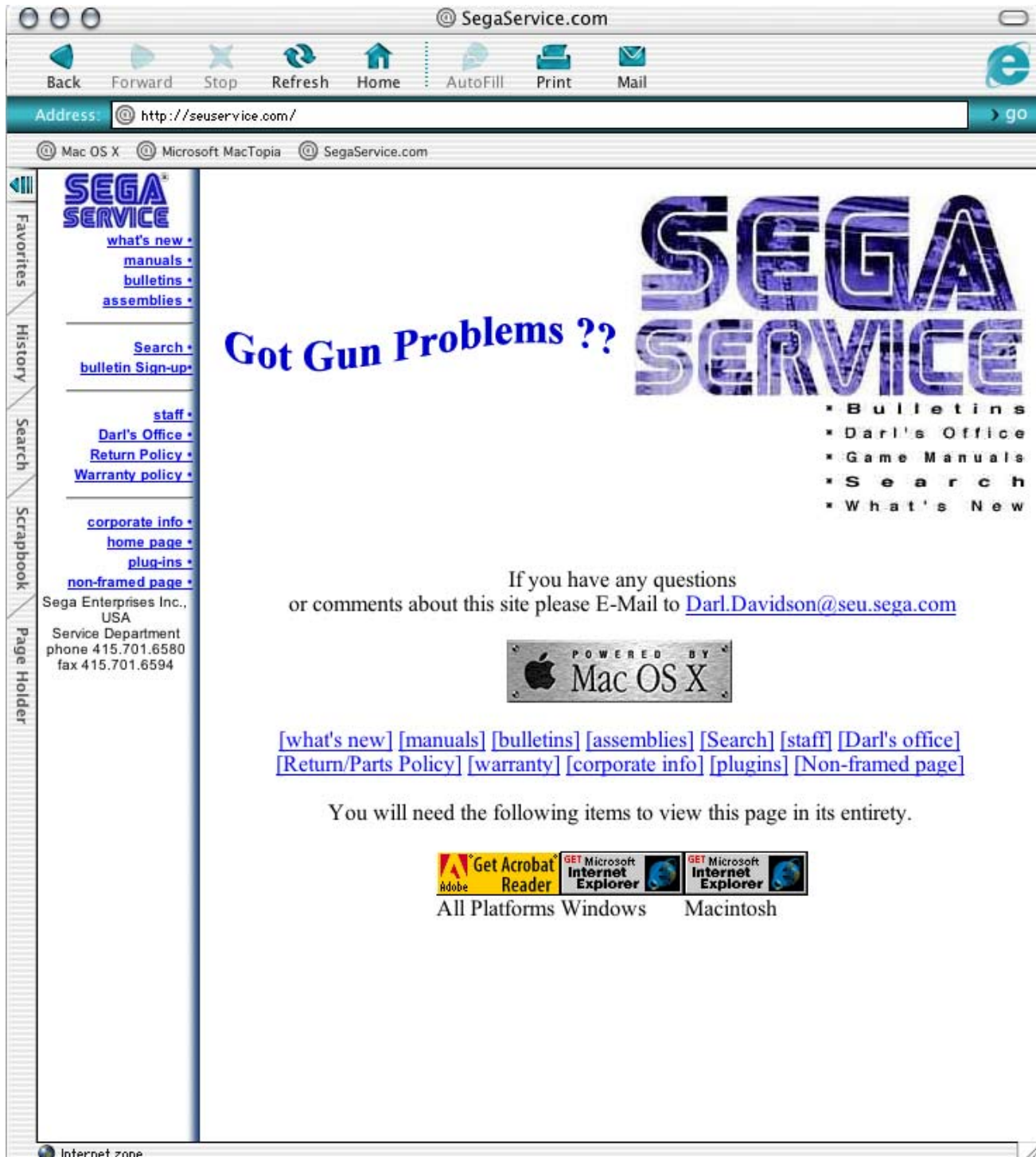

◆PRODUCTION DATE◆

This Product was produced in the year of:
2002

BEFORE USING THE PRODUCT, BE SURE TO READ THE FOLLOWING:

To maintain the safety:

To ensure the safe usage of the product, be sure to read the following before using the product. The following instructions are intended for the users, operators and the personnel in charge of the operation of the product. After carefully reading and sufficiently understanding the warning displays and cautions, handle the product appropriately. Be sure to keep this manual nearby the product or elsewhere convenient for referring to it when necessary.

Herein, explanations which require special attention are enclosed with dual lines. Depending on the potentially hazardous degrees, the terms of WARNING, CAUTION, etc. are used. Be sure to understand the contents of the displays before reading the text.



Indicates that mishandling the product by disregarding this warning will cause a potentially hazardous situation which can result in death or serious injury.



Indicates that mishandling the product by disregarding this caution will cause a slight hazardous situation which can result in personal injury and or material damage.

For the safe usage of the product, the following pictographs are used:



Indicates “HANDLE WITH CARE.” In order to protect the human body an equipment, this display is attached to places where the Owner’s Manual and or Service Manual should be referred to.

- **Perform work in accordance with the instructions herein stated.**
Instructions for work are explained by paying attention to the aspect of accident prevention. Failing to perform work as per the instructions can cause accidents. In the case where only those who have technical expertise should perform the work to avoid hazardous situation, the instructions herein state that the serviceman should perform such work.
- **Be sure to turn off power before working on the machine.**
To prevent electric shock, be sure to turn off power before starting the work in which the worker touches the interior of the product. If the work is to be performed in the power-on status, the Instruction Manual herein always states to that effect.
- **Be sure to ground the Earth Terminal** (this, however, is not required in the case where a power cord with earth is used).
This product is equipped with the Earth Terminal. When installing the product, Connect the Earth Terminal to the “accurately grounded indoor earth terminal” by using an earth wire. Unless the product is grounded appropriately, the user can be subject to electric shock. After performing repair, etc. for the Control equipment, ensure that the Earth Wire is firmly connected to the Control equipment.
- **Ensure that the Power Supply used is equipped with an Earth Leakage Breaker.**
This product does not incorporate the Earth Leakage Breaker. Using a power supply which is not equipped with the Earth Leakage Breaker can cause a fire when earth leakage occurs.
- **Be sure to use fuses which meet the specified rating.** (only for the machines which use fuses).
Using fuses exceeding the specified rating can cause a fire and electric shock.

- **Specification changes (removal of equipment, conversion and addition) not designated by SEGA are not allowed.**
The parts of the product include warning labels for safety, covers for personal protection, etc. It is very hazardous to operate the product by removing parts and or modifying the circuits. Should doors, lids and protective parts be damaged or lost, refrain from operating the product, and contact where the product was purchased from or the office herein stated. SEGA shall not be held responsible for any accidents, compensation for damage to a third party, resulting from the specifications not designated by SEGA.
 - **Ensure that the product meets the requirements of appropriate Electrical Specifications.**
Before installing the product, check for Electrical Specifications. SEGA products have a nameplate on which Electrical Specifications are described. Ensure that the product is compatible with the power supply voltage and frequency requirements of the location. Using any Electrical Specifications different from the designated Specifications can cause a fire and electric shock.
 - **Install and operate the product in places where appropriate lighting is available, allowing warning labels to be clearly read.**
To ensure safety for the customers, labels and printed instructions describing potentially hazardous situation are applied to places where accidents can be caused. Ensure that where the product is operated has sufficient lighting allowing the warnings to be read. If any label is peeled off, apply it again immediately. Please place an order with where the product was purchased from or the office herein stated.
 - **When handling the Monitor, be very careful. (Applies only to the product w/monitor.)**
Some of the monitor (TV) parts are subject to high tension voltage. Even after running off power, some portions are still subject to high tension voltage sometimes. Monitor repair and replacement should be performed only by those technical personnel who have knowledge of electricity and technical expertise.
 - **Be sure to adjust the monitor (projector) properly. (Applies only to the product w/monitor.)**
Do not operate the product leaving on-screen flickering or blurring as it is. Using the product with the monitor not properly adjusted may cause dizziness or a headache to an operator, a player, or the customers.
 - **When transporting or reselling this product, be sure to attach this manual to the product.**
In the case where commercially available monitors and printers are used in this product, only the contents relating to this product are explained herein. Some commercially available equipment has functions and reactions not stated in this manual. Read this manual together with the specific Instruction Manual of such equipment.
- Descriptions herein contained may be subject to improvement changes without notice.
 - The contents described herein are fully prepared with due care. However, should any question arise or errors be found, please contact SEGA.

INSPECTIONS IMMEDIATELY AFTER TRANSPORTING THE PRODUCT TO THE LOCATION.

Normally, at the time of shipment, SEGA products are in a status allowing for usage immediately after transporting to the location. Nevertheless, an irregular situation may occur during transportation. Before turning on power, check the following points to ensure that the product has been transported in a satisfactory status.

- Are there any dented portions or defects (cuts, etc.) on the external surfaces of the cabinet?
- Are Casters and Adjusters, damaged?
- Do the power supply voltage and frequency requirements meet with those of the location?
- Are all wiring connectors correctly and securely connected? Unless connected in the correct direction, connector connections can not be made accurately. Do not insert connectors forcibly.
- Do power cords have cuts and dents?
- Do the fuses used meet specified rating? Is the Circuit Protector in an energized status?
- Are all accessories available?
- Can all Doors and Lids be opened with the Accessory keys? Can Doors and Lids be firmly closed?

Virtua Fighter 4 Evolution

Sega Naomi 2 System

Kit Contains List

Part #	Desc	Qty
840-0106D-01	ASSY CASE NET VF4EV USA	1
400-5397-01	SW REGU FOR JVS	1
560-5407-UL	TRANSFORMER, 120V 17V2A	1
600-7009-2500	RGB CABLE	1
600-7141-250	CABLE JVS TYPE A-B 250CM	1
600-7158-0100	CA AUDIO RCA TO RCA 2CH	1
838-13616	AUDIO POWER AMP	1
838-13683-02	JAMMA I/O BD	1
999-1518	MARQUEE ART	1
999-1519	INSTRUCTION SHEET	1
999-1520	DECAL SIDE ART	2
999-1521	CONTROL PANEL	1
421-7988-91	STICKER SERIAL NUMBER	1
999-1517	KIT MANUAL -VF4 EVOLUTION	1
999-1515	INST. SHEET PLAYER	1

Parts not supplied in kit, but required for operation.

Suggested Happ #	Desc	Qty
42-2093-00	6vdc Coin Meter	1
	Test Switch	1
	Service Switch	1
	5k Pot (for Volume Control)	1
50-7608-XX	8way JoyStick	2
58-9111-LXPLY	SPST Momentary Switch (Start)	2
58-91XX-L	SPST Momentary Switch (Punch)	2
58-91XX-L	SPST Momentary Switch (Kick)	2
58-91XX-L	SPST Momentary Switch (Defence)	2
	VGA or NTSC RGB Monitor	1

DESIGNED RELATED PARTS

MARQUEE ART

999-1518



CTRL PNL OVERLAY

999-1521



SIDE ART

999-1520

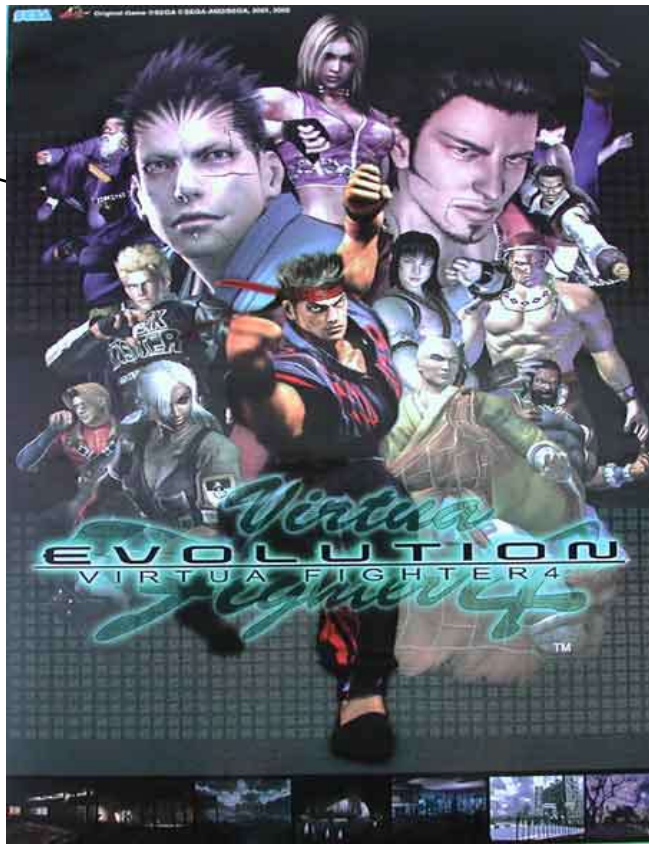

INSTR. SHEET (moves)

999-1519



INSTR. SHEET (player)

999-1515





SERVICE BULLETIN

SEGA Service Department
45133 Industrial Drive
Fremont, Ca. 94538

<http://www.seuservice.com>
Phone: 415.701.6580
Fax: 415.701.6594

SPECIAL NOTICE FOR ALL SEGA NAOMI KITS

PROBLEM:

The SEGA Naomi Game kits are actually 'JAMMA Dependent'. What this means exactly is they will only install into existing JAMMA Cabinets. If an operator tries to install these kits into a Non-JAMMA cabinet, they will first have to bring the wiring up to JAMMA Standards.

SOLUTION:

- Step 1 Disconnect the games original DC Power Supply. You may only use the power supply provided with your kit. Be sure to set the voltages going to your Game BD to 5.1 and 3.3 volts DC to assure proper operation (Measure on Square Connector at Game BD. Yellow = 5vdc / Brown = 3.3vdc / White = Gnd)
- Step 2 You **MUST USE THE COIN METER SUPPLIED WITH YOUR KIT** to assure proper Coin acceptance. A minimum 18 Gauge wire should be used from the Coin Meter 1 output line on your JAMMA Harness. The 5vdc (Yellow) wire found in the wiring bag of your kit **MUST BE USED** for the supply voltage to the meter.



IMPORTANT!

Not following the directions provided herein may cause your game to malfunction.
All electrical work should be performed by the site's Serviceman or Technician.



WARNING!

- In order to prevent an electric shock and short circuit, be sure to turn power off before performing work or touching the interior parts of the product.
- Be careful so as not to damage wirings. Damaged wiring can cause an electric shock or short circuit accident.
- Do not touch places other than those specified. Touching places not specified can cause an electric shock or short circuit accident.

If you have any questions please contact the SEGA Service Department at the numbers given above.

INSTALLATION INSTRUCTIONS

- 1) Turn off power and unplug machine. Open all access panels. Locate the original game Power Supply, Game BD, I/O BD, Sound BD etc... Remove these items from your cabinet. Remove all artwork from cabinet. Clean Cabinet Exterior and repair as necessary to assure good appearance.
- 2) Remove all existing harnesses. Install a new JAMMA Harness (Recommended). Please note that this harness is NOT SUPPLIED with your kit. DO NOT connect the 5vdc, 12vdc, GND or any other power line from the JAMMA Harness to the Power Supply. Note: If you are using a VGA compatible monitor you can run your VGA cable directly to the monitor or connect it to your JVS JAMMA interface for RGB conversion to your JAMMA cables.
- 3) Install the Components supplied in your kit (Game BD, Power Supply, Amp, Transformer etc.). Follow the wiring diagram for proper electrical connection (located at the end of the kit manual). Be careful to fasten all components securely. Route wires in a manner not to allow for pinching or binding. Secure wires once connected.

Vacuum out or clean bottom of cabinet of dirt & miscellaneous parts (e.g. screws, loose coins / tokens, etc.).

 Good Idea!

 Good Idea!

Remove all exterior decals and repair any cabinet damage. Repaint cabinet if necessary. Remove the Monitor Plexi or if your game plexi has Silk-screened artwork, you will need to strip it off.

- 4) Connect your cabinet's existing Service Switch Bracket Assy to the Kit Harness (Follow Diagram). Please note that you MUST USE a COIN METER for the game system to properly accept coins (Refer to Diagrams and Service Bulletin included in this manual).
- 5) Remove all Joystick Buttons and Pushbuttons from your Control Panel. Remove the existing overlay. Clean off all glue residues, and fill in or plug existing holes to give you a blank work area for your new game.
- 6) Install your Control Panel Art supplied with the kit. Cut holes in the overlay where controls are to be installed. Install and connect your controls. Please note that Joysticks and Pushbuttons are NOT SUPPLIED with your kit. You will need to supply 2ea 8way Joysticks, 2ea Start Buttons, and 2ea Punch, Kick and Defense buttons.
- 7) Connect your Coin Switches to the game harness following the diagram in the back of the manual.
- 8) Turn on Power to the game and check for proper voltages on either connector entering the Game BD Filter BD. The proper voltages are: 5.1vdc between Yellow and White, 3.30vdc between Brown and White. Adjust where necessary. Adjustment can be made at the Power Supply by using an insulated flat screwdriver. Turn clockwise to increase. Turn counter-clockwise to decrease.

INSTALLATION INSTRUCTIONS

- 9) Finish installation by installing Side Decals, Marquee and any instruction decals. Play your machine to verify proper operation. Set up options as desired.

Adjust the **SIZE, CONTRAST, BRIGHTNESS, and COLORS** on the Monitor for optimum appearance. Adjust **VERTICAL/HORIZONTAL Hold** to get a stable picture, if required.



Enter **DIAGNOSTICS** and adjust the Volume Level, test all Buttons & Joystick for proper operation & wiring. Adjust Pricing. Coin-Up and test out a game to ensure proper play functions are as they should be.

Sega Naomi System Switch Bracket and Speaker Installation Diagrams (Figure 3)

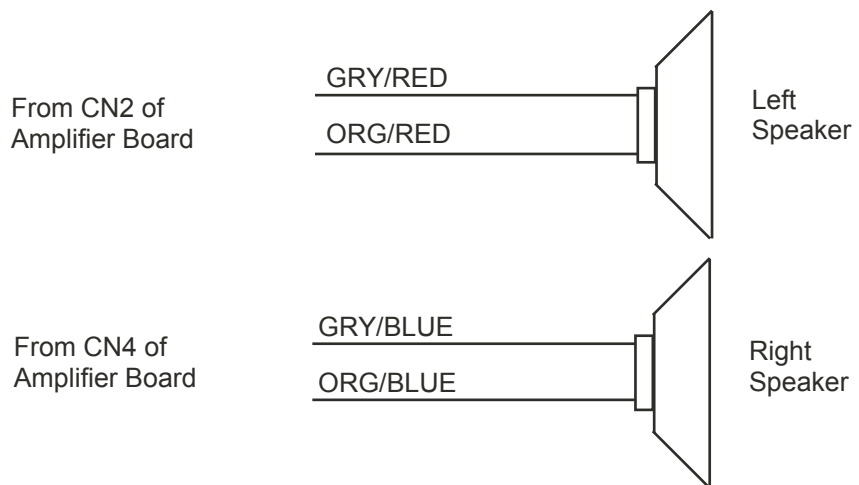
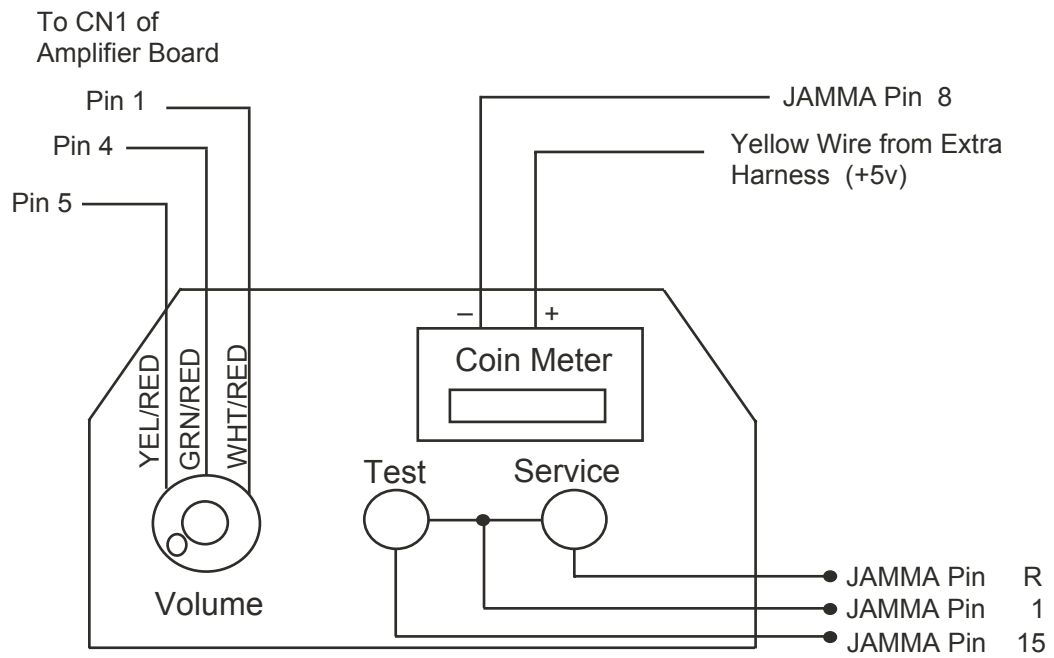

Sega Naomi System JAMMA Harness Wiring (JAMMA I/O BD) (Figure 4)

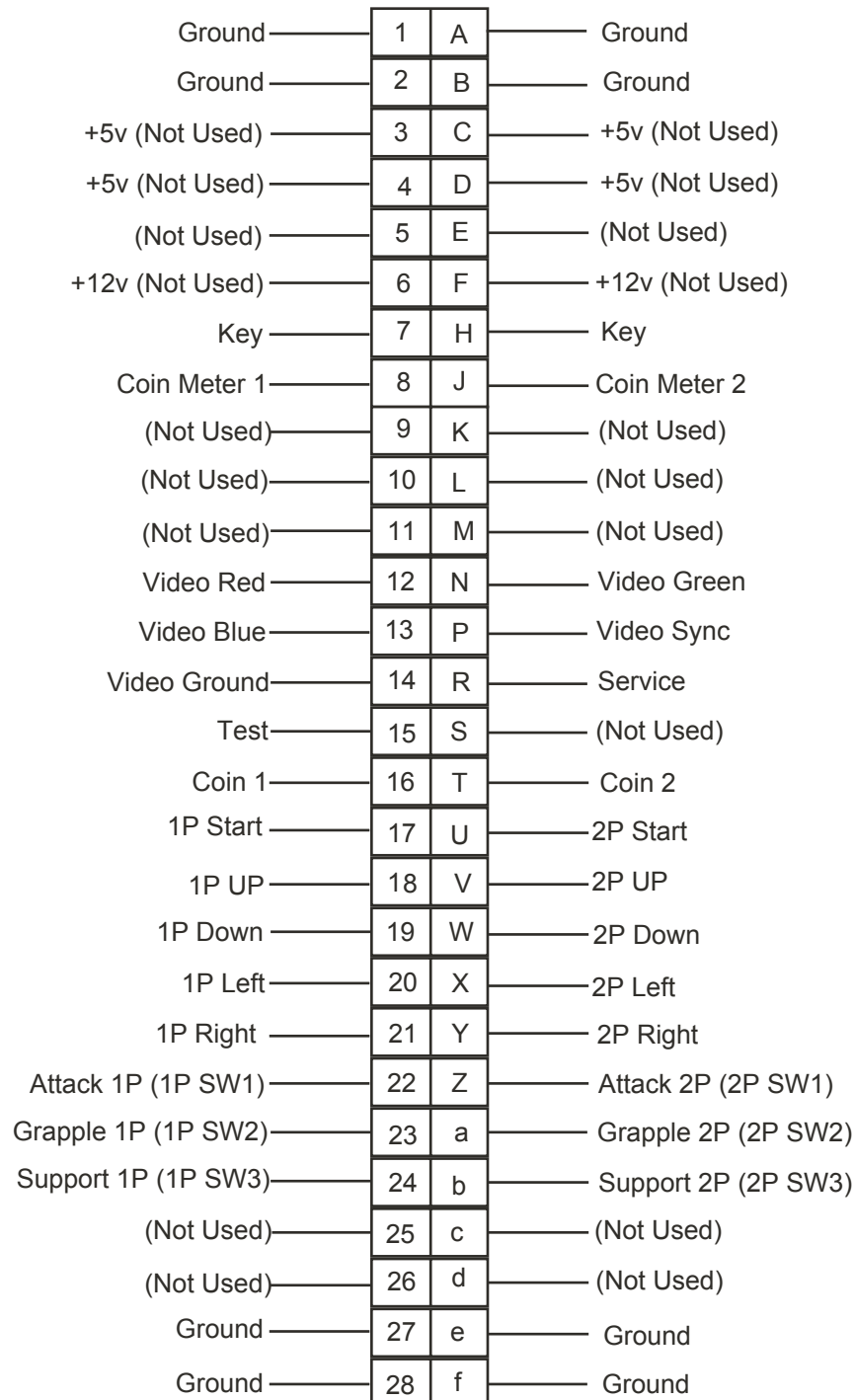

Sega Naomi System Filter Board Information Connector Description etc.

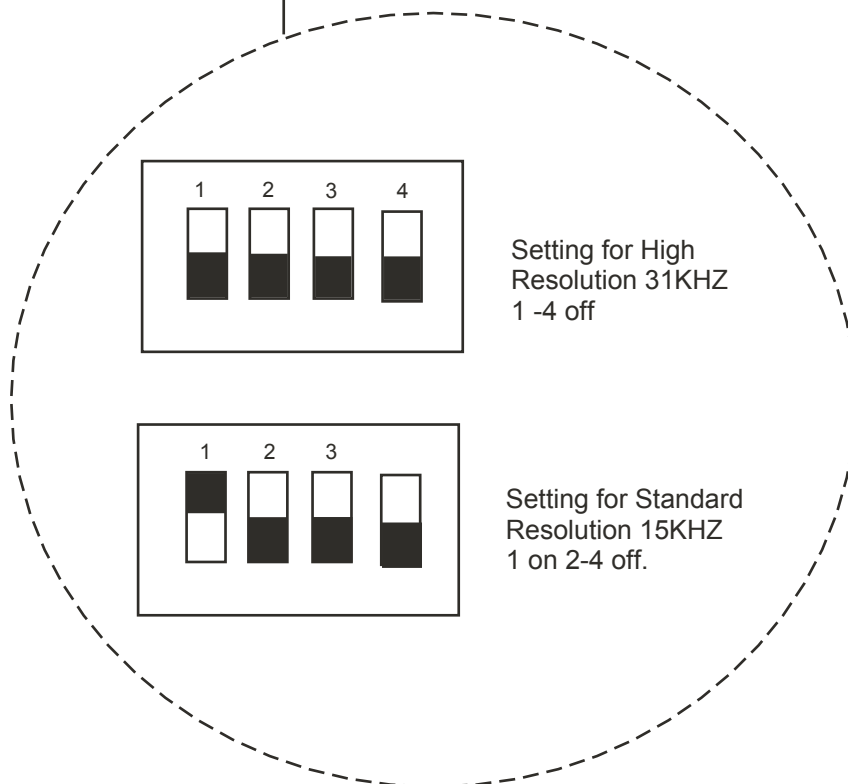
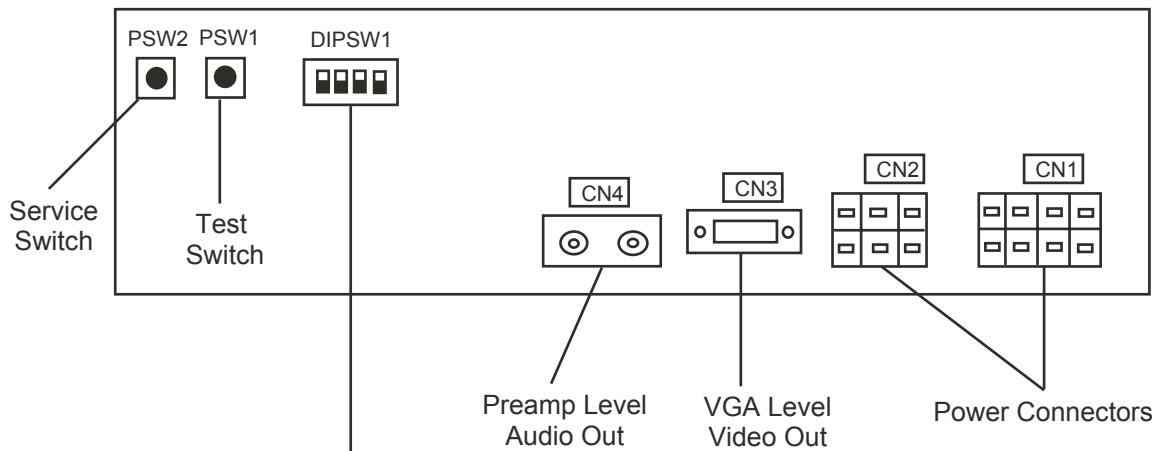

1. HANDLING PRECAUTIONS



- To prevent electric shock or IC Board malfunctioning, be sure to turn off the power for the cabinet when installing or removing the IC Board.
- Extraneous matter such as dust on the IC Board can cause the IC Board to generate heat and result in a fire due to short circuit, etc. Ensure the IC Board surfaces are always kept clean.
- Use NAOMI 2 for the cabinets compatible with JVS. Using NAOMI for the cabinet other than those compatible with JVS can cause generation of heat and a fire.



- Be sure to connect the IC Board and connectors completely. Insufficient insertion can damage IC Board, etc.
- For the IC Board circuit inspection, only the use of Logic Tester is permitted. The use of ordinary testers is not permitted as these can damage the IC Board.
- Do not subject the IC Board to static electricity when installing the IC Board in the cabinet or when connecting wire harness connectors to the IC Board.
- When soldering buttons, etc. to the wire harnesses, be sure to remove the wire harnesses from the IC Board so as not to subject the IC Board to heat.
- Using NAOMI 2 without the Shield Case can cause electric wave trouble. Be sure to use NAOMI 2 together with the accessory Shield Case.
- The monitor frequency corresponding to NAOMI 2 is 15 kHz or 31 kHz. NAOMI 2 can not be used for the cabinet incorporating a monitor or projector not corresponding to 15 kHz or 31 kHz.

- Concerning the display of JAMMA VIDEO STANDARD:
JAMMA VIDEO STANDARD adopted by NAOMI 2 is referred to as JVS. As against this Standard, the conventional JAMMA STANDARD which employs 56P Edge Connectors adopted by ST-V, etc. is displayed as Old JAMMA STANDARD.

The specific Manual attached to each game sometimes displays JVS as JV STANDARD, New JAMMA STANDARD, or JAMMA 2 STANDARD against OLD JAMMA STANDARD as JAMMA STANDARD, JS, etc.
- The contents herein described are subject to change without notice.

2. SPECIFICATIONS

- ON-SCREEN DISPLAY

Monitor Position



Horizontal Synchronous Frequency
31/15 kHz

- CONTROL PANEL

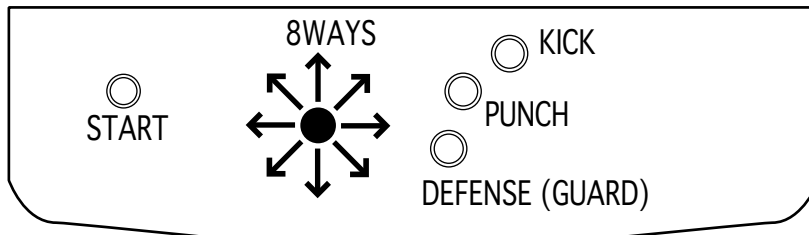

3. GAME DESCRIPTION

3 - 1 OUTLINE OF THE GAME

- You, as a martial art fighter, play in a tournament.
- For one-person match, you operate a playing character to fight against an opponent computer-operated character (CPU).
- For person-vs-person match, two players operate each playing character to fight against each other.
- The playing characters covers 15 selectable regular characters and 1 boss character.

3 - 2 PLAYING PROCEDURE

- Total 15 characters are available. Out of them you select one character to start the game.
- At each stage you play a match against a computer-operated character.
- Winning a match
 - Each match consists of multiple rounds. You win a match when the number of your gained rounds reaches a preset value.
 - When you win a match at any stage, you can proceed to a next stage and play a match against a new computer-operated character.
- Gaining a round

You can gain a round when either of the following events occurs.

 - You successfully reduce the opponent's energy to 0 (zero).
 - Your energy remains much more than the opponent's energy when the limit time has become 0 (zero).
 - You turn the opponent out of the ring.

When you and the opponent have drawn (that is, at the end of a round, both have a same level of energy or have knocked each other at the same time), both can gain the round exceptionally.

When you and the opponent have drawn under a sudden death state (that is, the number of the gained rounds is equal to each other and either can win the match by obtaining one more round), either with more energy becomes a winner of the match.
- When the GAME becomes OVER

The game is over when either of the following events occurs.

 - You lose a match against a computer-operated character.
 - You finish all the 11 stages: 10 stages, each with a regular computer-operated character, and 1 stage with a boss computer-operated character.
- Continuing the game

You can continue the game as follows.

 - When you lose a match, the CONTINUE screen appears.
 - Insert the credit coins before the limit time is counted down to 0 (zero) on the CONTINUE screen, and press the start button. Then, you can continue the game (or resume the first round of the stage where you lost a match).

3 - 3 CHARACTER SELECT SCREEN

- You select one out of the 15 available characters.
- Each character indicates its name, figure and profile.
- Place the lever in an upper, lower, left, or right position to migrate from character to character, and press either of the punch, kick, and defense buttons to select a character.
- Hold down the start button and press either of the punch, kick, and defense buttons to toggle between 1P character's color and 2P character's color.

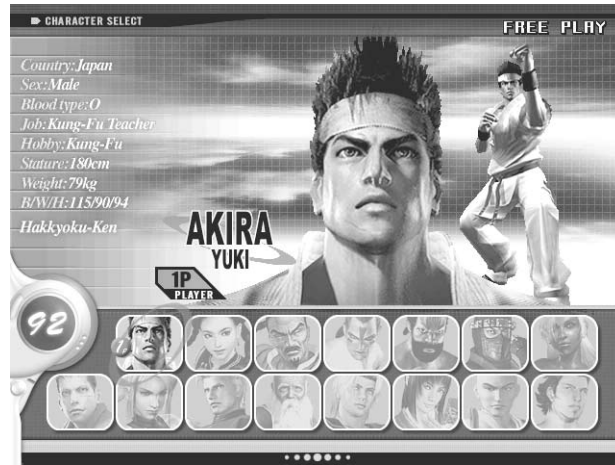

3 - 4 GAME-PLAYING SCREEN

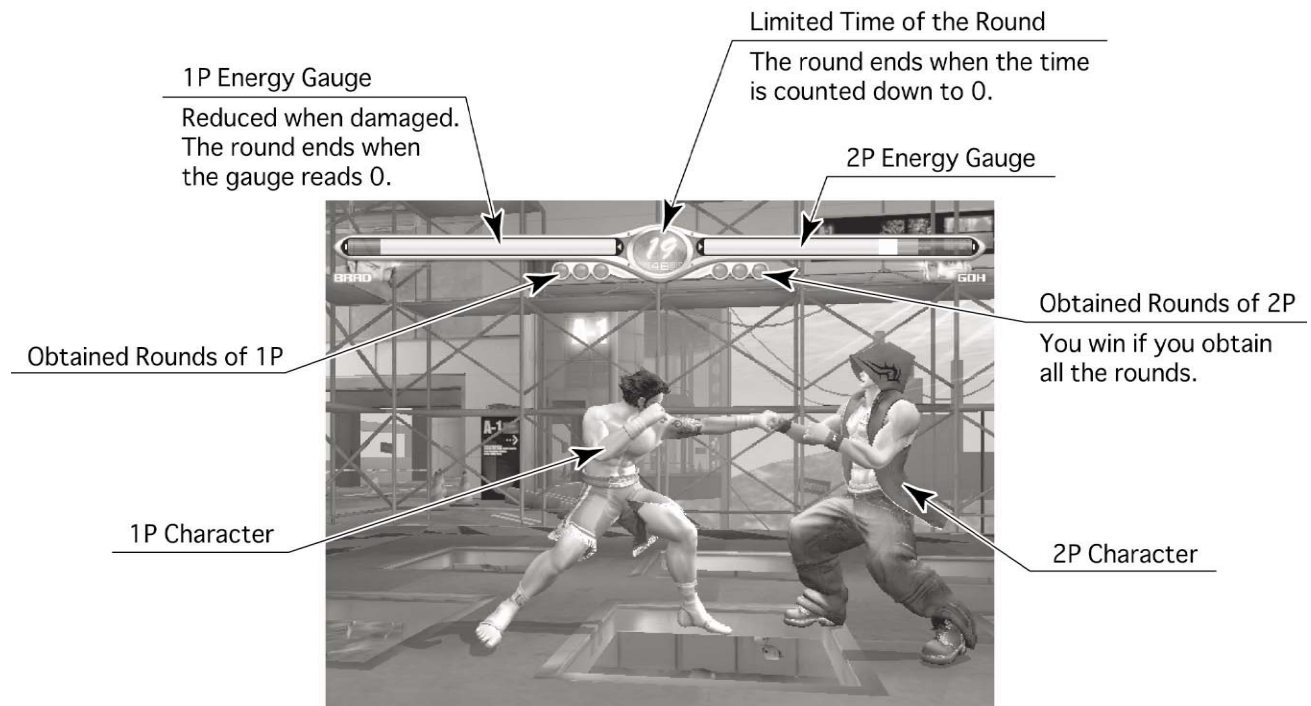

3 - 5 BASIC OPERATIONS OF THE CONTROLS

The following explains the operation for a 1P character. For a 2P character, read right and left reverse.

The following abbreviations are used herein.

P: Punch button

K: Kick button

G: Defense (Guard) button

+: Operating the two or more controls at the same time

- P: Punching attack
- K: Kicking attack
- G: Defending upper and middle parts
- Lever in a lower position + G: Defending lower part
(Note: The opponent may attack you at your upper, middle, or lower part. You must defend your upper, middle, or lower part accordingly.)
- Lever in a right position: Moving forwards
- Lever in a left position: Moving backwards
- Lever in an upper position instantly: Dodging away from you
- Lever in a lower position instantly: Dodging toward you
- P or K + lever in an upper position: Jumping upwards
- P or K + lever in an upper right position: Jumping diagonally forwards
- P or K + lever in an upper left position: Jumping diagonally backwards
- Lever in a right position two times quickly: Dashing forwards
- Lever in a left position two times quickly: Dashing backwards
- Lever in a lower right position two times quickly: Crouching and dashing forwards
- Lever in a lower left position: two times quickly: Crouching and dashing backwards
- Lever held in a lower position: Crouching
- P + G when you are close to the opponent: Throwing
- P + G when the opponent is throwing you: Escaping the throw (slipping)
- Lever in an upper position + P for the downed opponent: Jumping and attacking the downed opponent
- Repeated G when you are downed: Standing up quickly
- Repeated K when you are downed: Kicking attack immediately after quickly standing up
- Lever in a left position + repeated G when you are downed: Rolling backwards and standing up
- Lever in an upper/down position + repeated G when you are downed: Rolling left/right and standing up
- Continuously operated lever in a left/right position when you are faltering: Unfaltering quickly

3 - 6 SPECIAL OPERATIONS OF THE CONTROLS

Dodging/Attacking

Immediately after surely dodging by a lever operation, you attack an opponent. Thus you can use the combination of dodging/attacking skills.

Lever in an upper position instantly + P + K + G: Dodging away from you and attacking

Lever in a lower position instantly + P + K + G: Dodging toward you and attacking

Recovery (Ukemi = safe ways of falling down)

The ukemi enables you to regain your balance just when landing and to immediately attack an opponent. This skill lessens damage to you. Thus you can escape from the crunch and rather earn a chance to counterattack. You may be just downed or use the ukemi, whichever is tactically desirable in each situation.

P + K + G immediately before you are downed: Ukemi

Charge Attack (attacking with the accumulated energy)

Using the energy accumulated for a little time, you can destroy an opponent's defenses. This high-risk, high-return skill enhances your tactical capabilities. Special commands, one each with a character, are available to activate this function.

Fighting by the walls

- You may damage and destroy the walls. Thereby you can change the state of the ring as tactically required.
- The opponent may falter when you throw him/her against the walls. This enables you to use the combination (Combo) skills.

3 - 7 PERSON-VS-PERSON (VS) MATCHS

- A new player may join you in playing the GAME or selecting a character. As a result the system suspends the current one-person match against a computer-operated character and starts a person-vs-person match.
- The new player must insert the credit coins before joining.
- After playing the person-vs-person match only the winner can continue to play the suspended match: one-person match against a computer-operated character. He/she resumes the first round of the suspended match.



PERSON-VS-PERSON (VS) MATCHS • CHARACTER SELECT SCREEN

- When you have set the STAGE item to RANDOM on the GAME ASSIGNMENTS screen, the built-in computer (CPU) randomly selects a stage.
- When you have set the STAGE item to SELECTIVE on the GAME ASSIGNMENTS screen, the newly joined player selects a stage. (For more information see the chapter 4, B, b. "GAME ASSIGNMENTS.") To select, he/she places the lever in an upper, lower, left, or right position to migrate from stage to stage, and presses either of the punch, kick, and defense buttons.



PERSON-VS-PERSON (VS) MATCHS • STAGE SELECT SCREEN

4. TEST MODE

A. SYSTEM MENU



When settings are changed in SYSTEM ASSIGNMENTS, COIN ASSIGNMENTS, and GAME ASSIGNMENTS of GAME TEST MODE, be sure to exit from the test mode of SYSTEM MENU screen. The contents of setting changes are stored in the IC on the BOARD when exiting from the Test Mode. If the power is turned off in the Test Mode (before exiting), the contents of setting changes are ineffective. In this case, the settings remain unchanged.

This test mode mainly allows the IC Board to be checked for accurate functioning, monitor color to be adjusted as well as COIN ASSIGNMENTS and GAME ASSIGNMENTS to be adjusted.

- 1) Connect the power, and press the TEST Button. Then the following SYSTEM MENU screen appears.

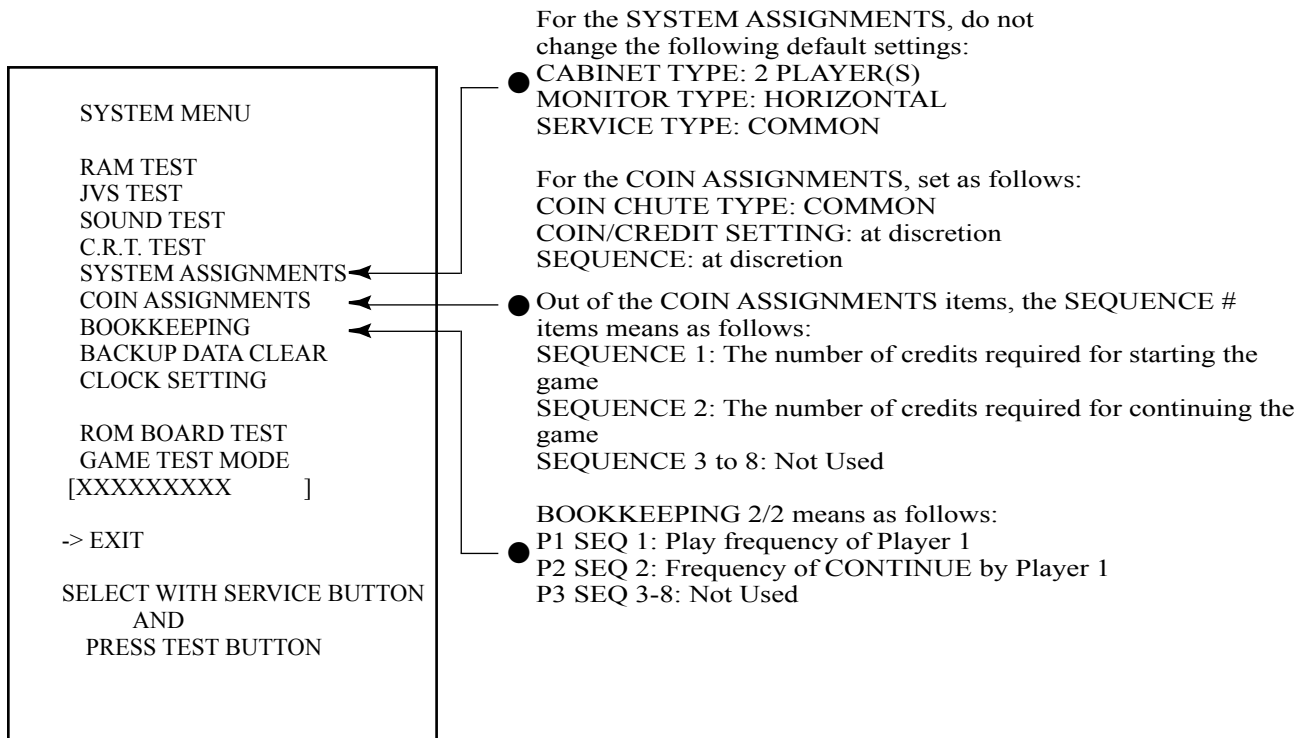

- 2) Press the SERVICE Button to move the -> mark to any desired item, and press the TEST Button.
- 3) Press the SERVICE Button to move the -> mark to GAME TEST MODE item, and press the TEST Button. Then the GAME TEST MENU screen appears that enables to test the items specific to this game. For the details, see the following pages.
- 4) After testing, select the EXIT and press the TEST Button. The game advertising screen reappears.

NOTE: For more information about the SYSTEM MENU screen, see the NAOMI 2 Service Manual.

B. GAME TEST MODE

Press the SERVICE Button to move the arrow mark to the GAME TEST MODE item on the SYSTEM MENU screen, and press the TEST Button. The GAME TEST MENU screen, specific for this game, opens.

Press the SERVICE Button to move the arrow mark to a desired test item on the GAME TEST MENU screen, and press the TEST Button to open the related screen.

After testing, move the arrow mark to the EXIT item and press the TEST Button. The SYSTEM MENU screen reappears

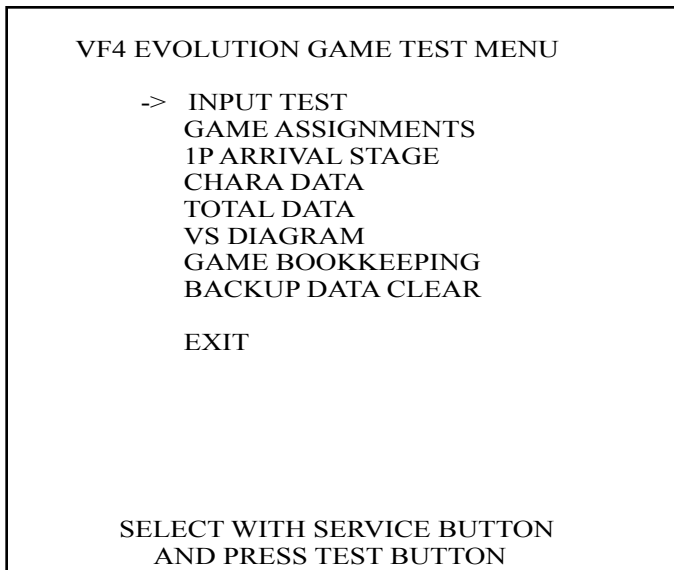

GAME TEST MENU Screen

a. INPUT TEST

This test displays the state of each switch and button.

If the switch goes ON when the switch/button is pressed, it is satisfactory.

Press SERVICE Button and TEST Button simultaneously to have the MENU return on to the screen.

INPUT TEST		
PLAYER	1P	2P
START	OFF	OFF
UP	OFF	OFF
DOWN	OFF	OFF
LEFT	OFF	OFF
RIGHT	OFF	OFF
GUARD	OFF	OFF
PUNCH	OFF	OFF
KICK	OFF	OFF
TEST	OFF	
SERVICE	OFF	

PRESS SERVICE+TEST BUTTON TO EXIT

INPUT TEST Screen

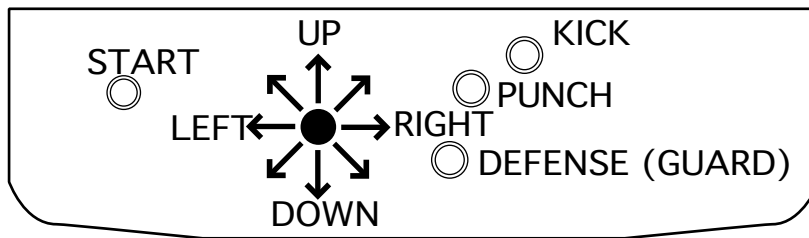

CONTROL PANEL

b. GAME ASSIGNMENTS

Allows game difficulty adjustments, time setting, etc. to be changed. Move the arrow to the desired item by SERVICE Button and press the TEST Button to change the setting. Select EXIT to return to the MENU screen.

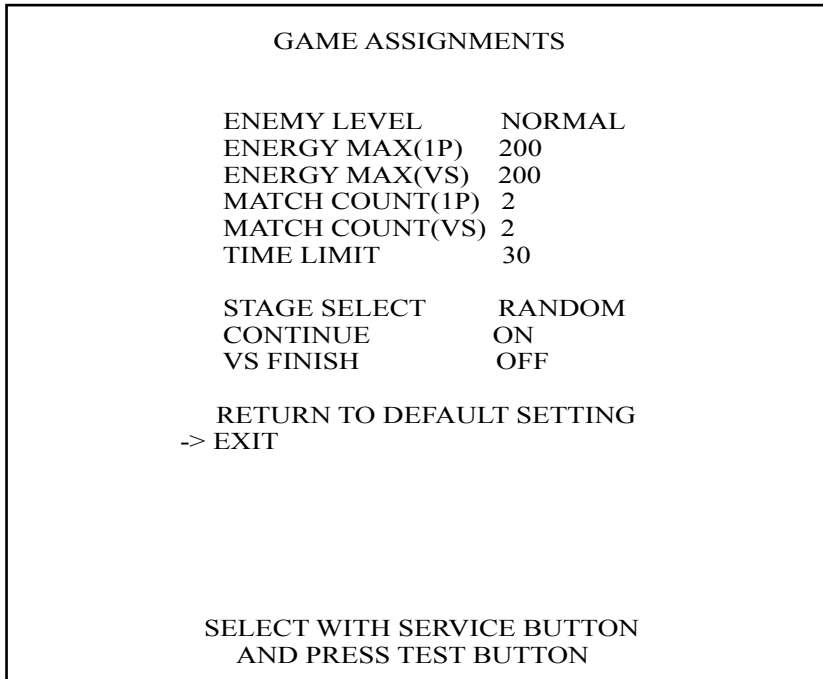

GAME ASSIGNMENTS Screen

- ENEMY LEVEL: Sets the difficulty level of the one-person match.
VERY EASY→EASY→NORMAL→HARD→VERY HARD (Default: NORMAL)
- ENERGY MAX (1P): Sets the energy (initial value) in a one-person game.
180→200→220→240 (Default: 200)
- ENERGY MAX (VS): Sets the energy (initial value) in a person-vs-person game.
180→200→220→240 (Default: 200)
- MATCH COUNT (1P): Sets the number of the rounds that a player aims to gain for winning the related match in a one-person game.
2→3→4→5 (Default: 2)
- MATCH COUNT (VS): Sets the number of the rounds that a player aims to gain for winning the related match in a person-vs-person game.
2→3→4→5 (Default: 2)
- TIME LIMIT: Sets the limit time of a match.
30→45→60 (Default: 30)
- STAGE SELECT: Sets the method of selecting a stage in a person-vs-person game.
RANDOM indicates an automatic selection by the computer.
RANDOM→SELECTIVE (Default: RANDOM)
- CONTINUE: Determines whether you can continue to play the lost match in a one-person game.
ON indicates that you can play the lost match.
ON→OFF (Default: ON)
- VS FINISH: Determines whether to finish the game after you have successfully played the matches.
The *WIN settings indicate that the game is finished for both the players after you have won consecutively * times (Note that the * mark is equal to 1 up to 10 or the number of winning matches as below). These settings are prepared for some competitions or events. Usually, therefore, set this item to OFF.
OFF→1 WIN→2 WINS→3 WINS→4 WINS→5 WINS→6 WINS →7 WINS→8 WINS→9 WINS→10 WINS
(Default: OFF)
- RETURN TO DEFAULT SETTING: Resets all the GAME ASSIGNMENTS items to the default values.
- EXIT: Returns to the GAME TEST MENU screen.

c. 1P ARRIVAL STAGE

Lists the playing statistics by difficulty level.

ARRIVAL STAGE 1/5		
1P GAME STAGE RECORDS		
VERY EASY		
	TOTAL	1COIN
#1	0	0
#2	0	0
#3	0	0
#4	0	0
#5	0	0
#6	0	0
#7	0	0
#8	0	0
#9	0	0
#10	0	0
#11	0	0
PRESS TEST BUTTON TO CONTINUE		

1P ARRIVAL STAGE 1/5 Screen

- **ARRIVAL STAGE 1/5:**
Indicates that the statistics is for a VERY EASY level of one-person game.
- **1COIN:**
Indicates how many times each stage has been reached in a VERY EASY level of one-person game, excluding the number of continuing.
- **TOTAL:**
Indicates how many times each stage has been reached in a VERY EASY level of one-person game, including the number of continuing.

Press the TEST Button to open the next screen. Press the TEST Button on the last 5/5 screen to return to the GAME TEST MENU screen.

- **ARRIVAL STAGE 2/5:** Indicates the similar statistics in an EASY level.
- **ARRIVAL STAGE 3/5:** Indicates the similar statistics in a NORMAL level.
- **ARRIVAL STAGE 4/5:** Indicates the similar statistics in a HARD level.
- **ARRIVAL STAGE 5/5:** Indicates the similar statistics in a VERY HARD level.

d. CHARA DATA

Lists the playing statistics by character. The following 1/15 screen is the example for the character named Akira.

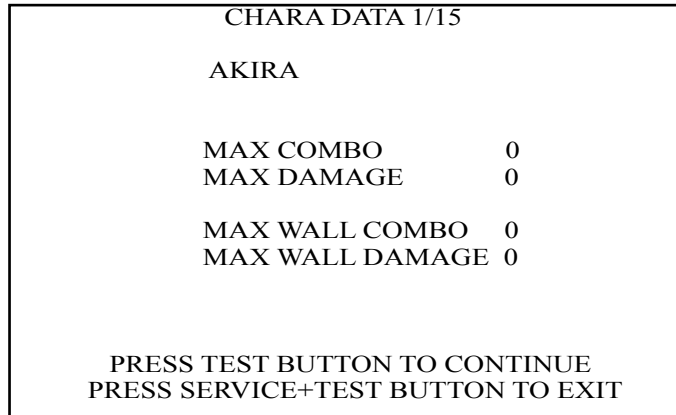

CHARA DATA 1/15 Screen

- MAX COMBO: Indicates the maximum number of the combos without walls.
- MAX DAMAGE: Indicates the maximum damages without walls.
- MAX WALL COMBO: Indicates the maximum number of the combos with walls.
- MAX WALL DAMAGE: Indicates the maximum damages with walls.

Press the TEST Button to open the next screen. Press the TEST Button on the last 15/15 screen to return to the GAME TEST MENU screen.

Press the TEST and SERVICE Buttons simultaneously to directly return to the GAME TEST MENU screen.

- CHARA DATA 2/15 SARAH: Indicates the similar statistics on Sarah.
- CHARA DATA 3/15 LAU: Indicates the similar statistics on Lau.
- CHARA DATA 4/15 SHUN: Indicates the similar statistics on Shun.
- CHARA DATA 5/15 JEFFRY: Indicates the similar statistics on Jeffry.
- CHARA DATA 6/15 PAI: Indicates the similar statistics on Pai.
- CHARA DATA 7/15 JACKY: Indicates the similar statistics on Jacky.
- CHARA DATA 8/15 KAGE: Indicates the similar statistics on Kage.
- CHARA DATA 9/15 LION: Indicates the similar statistics on Lion.
- CHARA DATA 10/15 WOLF: Indicates the similar statistics on Wolf.
- CHARA DATA 11/15 AOI: Indicates the similar statistics on Aoi.
- CHARA DATA 12/15 LEIFEI: Indicates the similar statistics on Lei Fei.
- CHARA DATA 13/15 VANESSA: Indicates the similar statistics on Vanessa.
- CHARA DATA 14/15 GOH: Indicates the similar statistics on Goh.
- CHARA DATA 14/15 BRAD: Indicates the similar statistics on Brad.

e. TOTAL DATA

Lists the entire statistics by character.

TOTAL DATA 1/1				
SERIES OF WINS			WINS OF CHARA	
1ST	20	AKIRA	AKIRA	0
2ND	20	SARAH	SARAH	0
3RD	20	LAU	LAU	0
4TH	20	SHUN	SHUN	0
5TH	19	JEFFRY	JEFFRY	0
6TH	19	PAI	PAI	0
7TH	19	JACKY	JACKY	0
8TH	18	KAGE	KAGE	0
9TH	18	LEIFEI	LION	0
10TH	18	AOI	WOLF	0
			AOI	0
			LEIFEI	0
			VANESSA	0
			GOH	0
			BRAD	0

PRESS TEST BUTTON TO EXIT

TOTAL DATA Screen

- SERIES OF WINS: Indicates the number of the consecutive winnings for each character.
- WINS OF CHARA: Indicates the accumulated number of the winnings for each character.

Press the TEST Button to return to the GAME TEST MENU screen.

f. VS DIAGRAM

Illustrates a matching diagram.

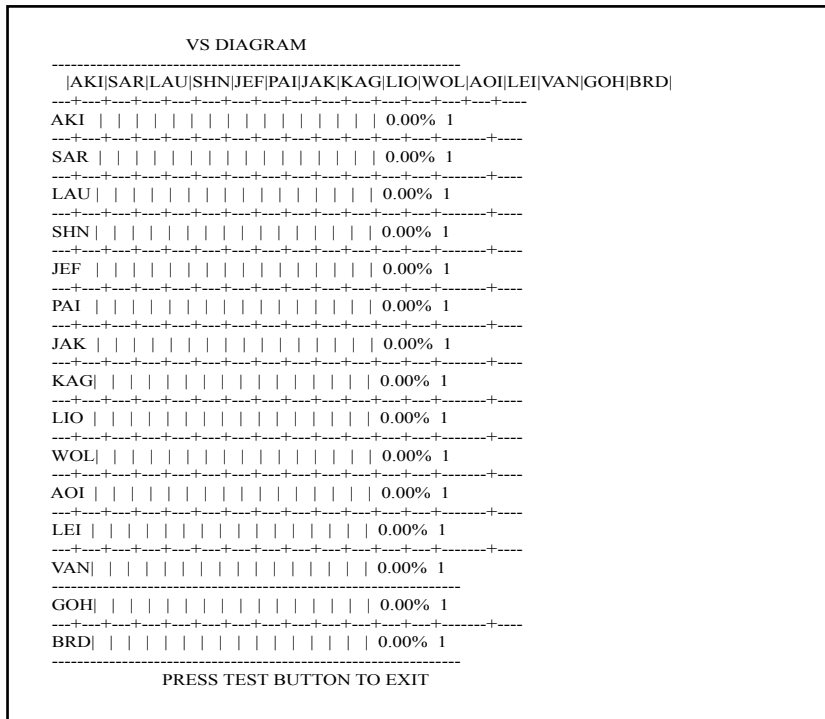

VS DIAGRAM Screen

The percentage of wins is indicated on the second rightmost column of the screen. The order of wins percentage is indicated on the rightmost column of the screen. Press the TEST Button to return to the GAME TEST MENU screen.

Abbreviations on the Screen for the Character Names

Abbreviations: Character Names

- AKI: AKIRA
- SAR: SARAH
- LAU: LAU
- SHN: SHUN
- JEF: JEFFRY
- PAI: PAI
- JAK: JACKY
- KAG: KAGE
- LIO: LION
- WOL: WOLF
- AOI: AOI
- LEI: LEI FEI
- VAN: VANESSA
- GOH: GOH
- BRD: BRAD

g. GAME BOOKKEEPING

Indicates the overall statistics. Three screens are available. Press the TEST Button to migrate from one screen to another. Press the TEST Button on the third screen to return to the GAME TEST MENU screen.

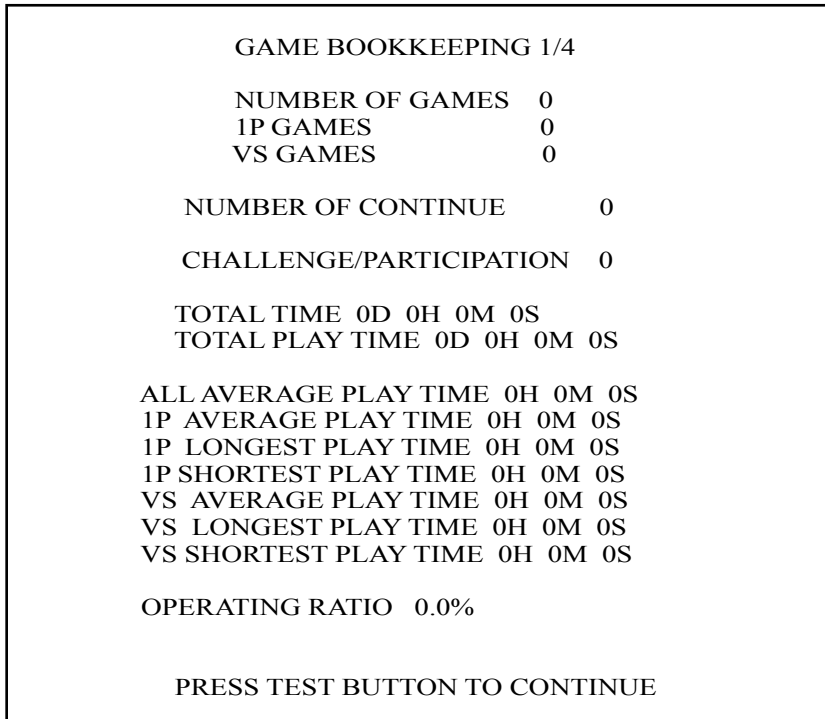

GAME BOOKKEEPING (1/4) Screen

- NUMBER OF GAMES: The total number of the games played
- 1P GAMES: The number of the one-person games played
- VS GAMES: The number of the person-vs-person games played
- NUMBER OF CONTINUE: The number of accumulated continuing-times
- CHALLENGE/PARTICIPATION: The number of accumulated joining-times
- TOTAL TIME: The accumulated power-up time period
- TOTAL PLAY TIME: The accumulated playing time period
- ALL AVERAGE PLAY TIME: The averaged playing time period (one-person + person-vs-person)
- 1P AVERAGE PLAY TIME: The averaged playing time period (one-person)
- 1P LONGEST PLAY TIME: The longest playing time period (one-person)
- 1P SHORTEST PLAY TIME: The shortest playing time period (one-person)
- VS AVERAGE PLAY TIME: The averaged playing time period (person-vs-person)
- VS LONGEST PLAY TIME: The longest playing time period (person-vs-person)
- VS SHORTEST PLAY TIME: The shortest playing time period (person-vs-person)
- OPERATING RATIO: TOTAL PLAY TIME/TOTAL TIME (%)

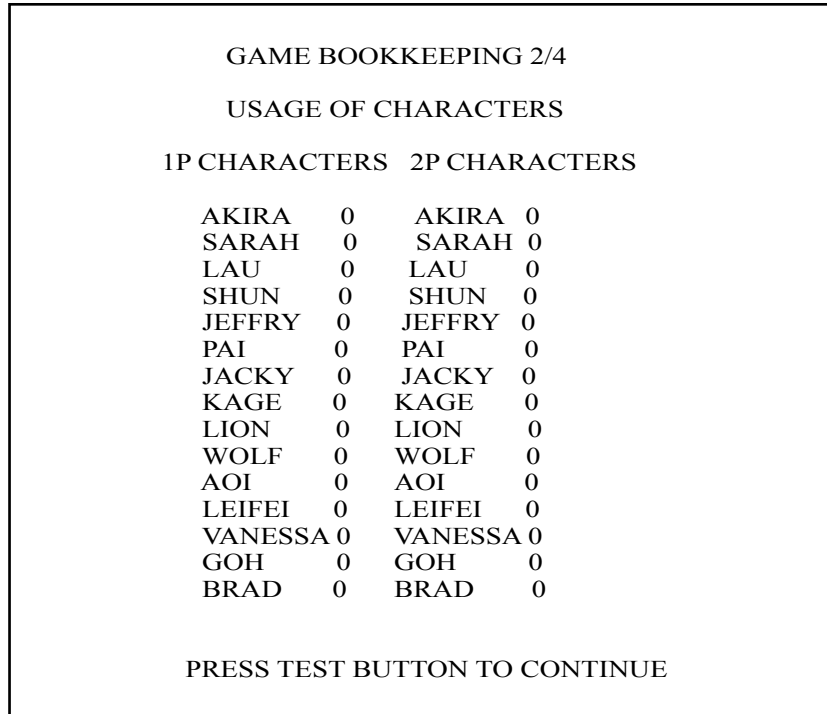

GAME BOOKKEEPING (2/4) Screen

Indicates how many times each character (for 1P and 2P) has been used.

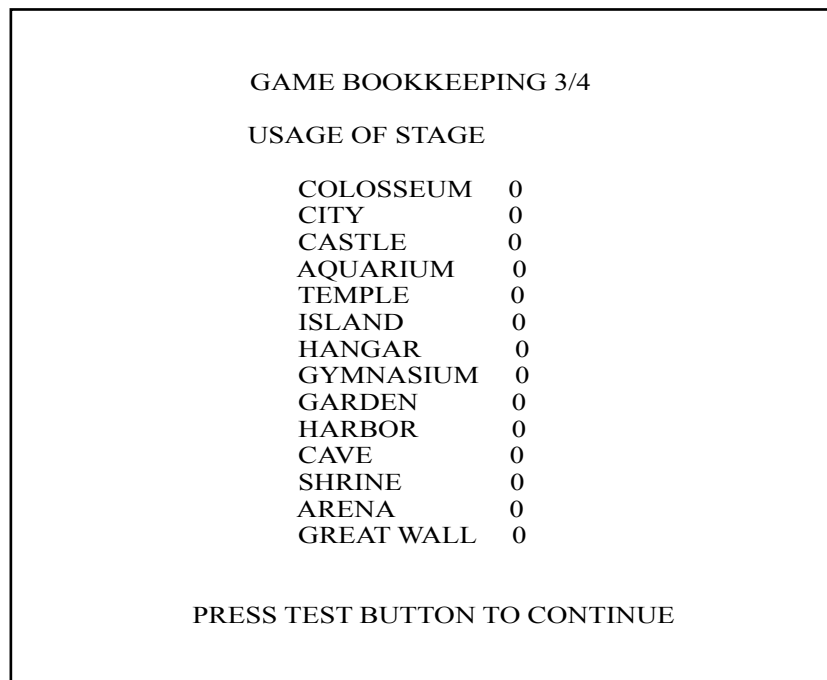

GAME BOOKKEEPING (3/4) Screen

Indicates how many times each stage has been used with the STAGE item set to SELECTIVE.

GAME BOOKKEEPING 4/4						
DAY	1P COIN	2P COIN	TOTAL COIN	COIN COIN	SERVICE CREDIT	TOTAL CREDIT
2002-06-12	20	-	20	20	-	20
2002-06-13	20	-	20	20	1	21
2002-06-14	24	-	24	24	-	24
•	•	•	•	•	•	•
•	•	•	•	•	•	•
•	•	•	•	•	•	•
-----	-	-	-	-	-	-
-----	-	-	-	-	-	-
-----	-	-	-	-	-	-
-----	-	-	-	-	-	-

PRESS TEST BUTTON TO EXIT

GAME BOOKKEEPING (4/4) Screen

Shows income information for a 30-day period. A new day starts at 24:00 (midnight). This function uses the internal clock, so ensure that the clock is set to the correct time using CLOCK SETTING in SYSTEM TEST MODE.

Income data is saved to memory at fixed times (during advertising, saving takes place while the Sega logo is displayed). Note that turning the power off or entering Test Mode before data save is complete will prevent data from being recorded.

h. BACKUP DATA CLEAR

Clears the backup data from the screen.

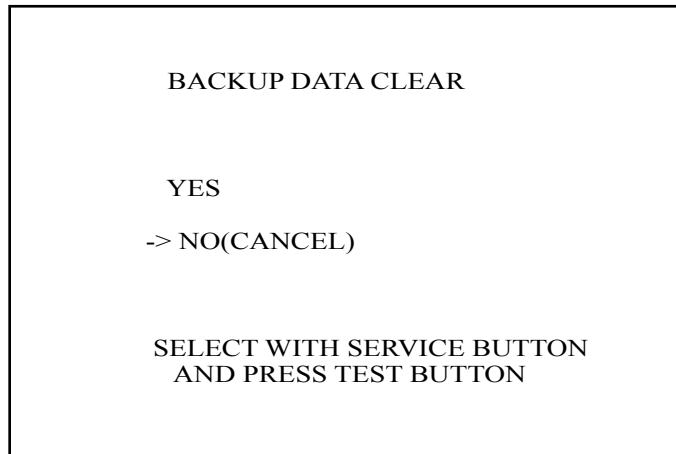

- YES: Opens the BACKUP DATA CLEAR - COMPLETED screen for clearing the following data. (The other data are not cleared.)
 - 1P ARRIVAL STAGE
 - CHARA DATA
 - TOTAL DATA
 - VS DIAGRAM
 - GAME BOOKKEEPING
- NO: Returns to the GAME TEST MENU screen.

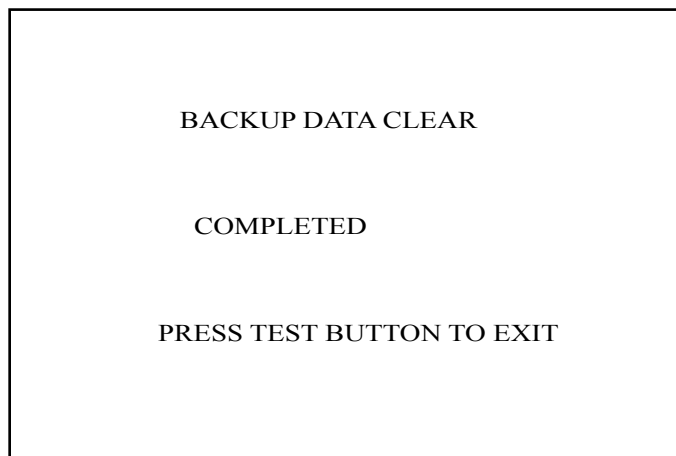

After clearing the backup data, the COMPLETED message appears.
Press the TEST Button to return to the GAME TEST MENU screen.

GAME BOARD



CAUTION!

- Do not expose the Game Board so as to avoid causing an accident or malfunctioning.
- Static electricity discharge can damage electronic parts on the IC Board. Before starting work by opening the Shield Case Lid, be sure to touch grounded metallic surfaces to discharge physically charged static electricity.
- When replacing the Game Board, refer to the CVT Manual and Instruction Manual.

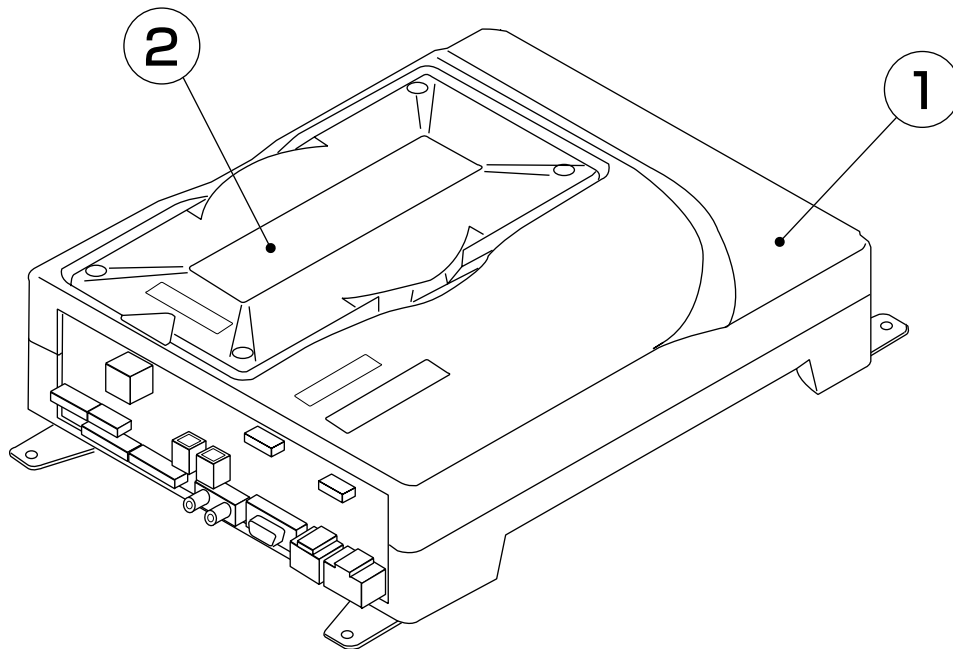

	PART NO.	DESCRIPTION
ASSY CASE (①+②)	840-0106D-01	ASSY CASE NAT VF4EV USA :USA
① ASSY CASE NAOMI 2 MAIN BOARD	840-0046A-01	ASSY CASE NAOMI 2 MAIN BD USA :USA (Not sold separately)
② ROM CASE	840-0106C	ROM CASE NAT VF4EV (Not sold separately)

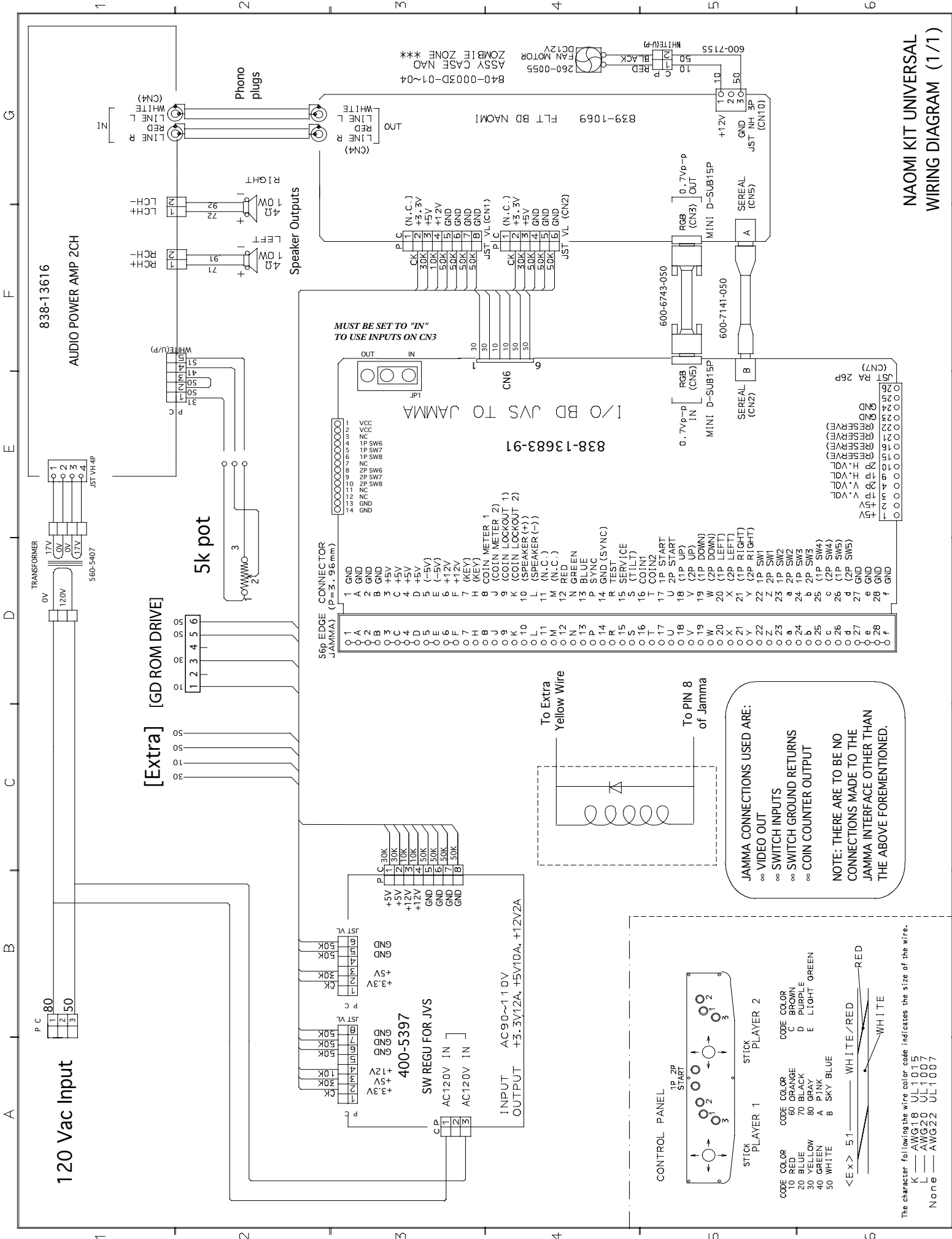

Notes:

Warranty

Your new Sega Product is covered for a period of 90 days from the date of shipment. This certifies that the Printed Circuit Boards, Power Supplies and Monitor are to be free of defects in workmanship or materials under normal operating conditions. This also certifies that all Interactive Control Assemblies are to be free from defects in workmanship and materials under normal operating conditions. No other product in this machine is hereby covered.

Sellers sole liability in the event a warranted part described above fails shall be, at its option, to replace or repair the defective part during the warranty period. For Warranty claims, contact your Sega Distributor.

Should the Seller determine, by inspection that the product was caused by Accident, Misuse, Neglect, Alteration, Improper Repair, Installation or Testing, the warranty offered will be null and void.

Under no circumstances is the Seller responsible for any loss of profits, loss of use, or other damages.

This shall be the exclusive written Warranty of the original purchaser expressed in lieu of all other warranties expressed or implied. Under no circumstance shall it extend beyond the period of time listed above.



SEGA ENTERPRISES, INC. (USA)

45133 Industrial Drive
Fremont, CA 94538
(415) 701-6580 phone
(415) 701-6594 fax